

GIA NATURAL COLORED DIAMOND REPORT

August 04, 2025
 Report Type Grading Report
 GIA Report Number 6233645959
 Shape and Cutting Style Pear Brilliant
 Measurements 6.23 x 3.96 x 2.59 mm

Carat Weight 0.39 carat
 Color Grade Fancy Pinkish Brown
 Color Origin Natural
 Color Distribution Even
 Clarity Grade SI1
 Proportions:

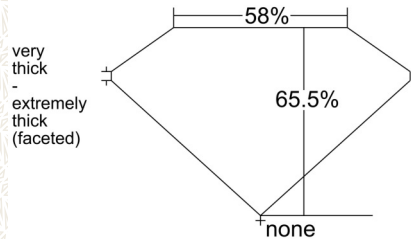

Profile not to actual proportions

Polish Very Good
 Symmetry Good
 Fluorescence None
 Inscription(s): GIA 6233645959

Comments: Clouds, pinpoints, internal graining and surface graining are not shown.

ADDITIONAL INFORMATION

GIA COLORED DIAMOND SCALE

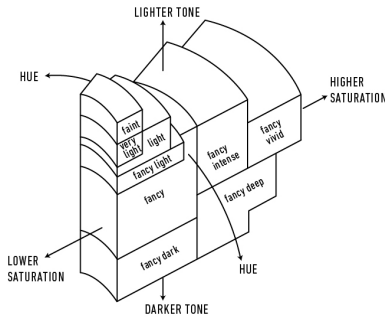
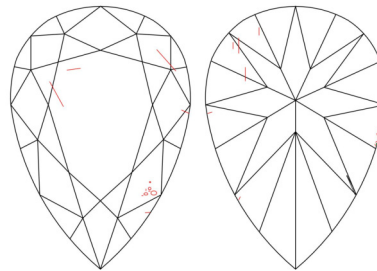

Illustration of GIA fancy color grade interrelationships





GIA CLARITY SCALE

| |
|--|
| FLAWLESS |
| INTERNALLY FLAWLESS |
| VERY VERY SLIGHTLY INCLUDED VVS ₁ |
| VERY VERY SLIGHTLY INCLUDED VVS ₂ |
| VERY SLIGHTLY INCLUDED VS ₁ |
| VERY SLIGHTLY INCLUDED VS ₂ |
| SLIGHTLY INCLUDED SI ₁ |
| SLIGHTLY INCLUDED SI ₂ |
| INCLUDED I ₁ |
| INCLUDED I ₂ |
| INCLUDED I ₃ |

CLARITY CHARACTERISTICS



KEY TO SYMBOLS*

-  Feather
-  Crystal
-  Needle
-  Indented Natural
-  Extra Facet

* Red symbols denote internal characteristics (inclusions). Green or black symbols denote external characteristics (blemishes). Diagram is an approximate representation of the diamond, and symbols shown indicate type, position, and approximate size of clarity characteristics. All clarity characteristics may not be shown. Details of finish are not shown.



reportcheck.gia.edu



The results documented in this report refer only to the diamond described, and were obtained using the techniques and equipment available to GIA at the time of examination. This report is not a guarantee or valuation. For additional information and important limitations and disclaimers, please see GIA.edu/terms or call +1 800 421 7250 or +1 760 603 4500. ©2023 Gemological Institute of America, Inc.

 THE SECURITY FEATURES IN THIS DOCUMENT, INCLUDING THE HOLOGRAM, SECURITY SCREEN AND MICROPRINT LINES, IN ADDITION TO THOSE NOT LISTED, EXCEED DOCUMENT SECURITY INDUSTRY GUIDELINES.