

GIA COLORED DIAMOND REPORT

June 30, 2014
 Report Type Grading Report
 GIA Report Number 6167277347
 Shape and Cutting Style Cushion Modified Brilliant
 Measurements 5.91 x 5.68 x 3.56 mm

 Carat Weight 1.00 carat
 Color Grade Fancy Dark Brown
 Color Origin Natural
 Color Distribution Even
 Clarity Grade I1
 Proportions:

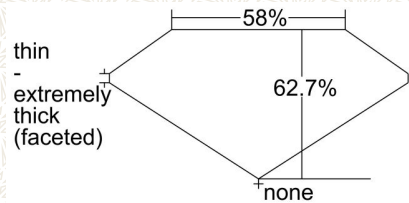

Profile not to actual proportions

Polish Excellent
 Symmetry Good
 Fluorescence None



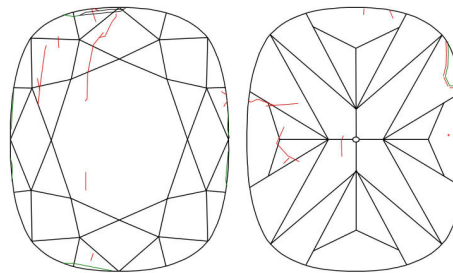

Comments: Internal graining is not shown.

ADDITIONAL INFORMATION

CLARITY CHARACTERISTICS



KEY TO SYMBOLS*

-  Feather
-  Extra Facet
-  Indented Natural
-  Pinpoint
-  Natural

* Red symbols denote internal characteristics (inclusions). Green or black symbols denote external characteristics (blemishes). Diagram is an approximate representation of the diamond, and symbols shown indicate type, position, and approximate size of clarity characteristics. All clarity characteristics may not be shown. Details of finish are not shown.

GIA COLORED DIAMOND SCALE

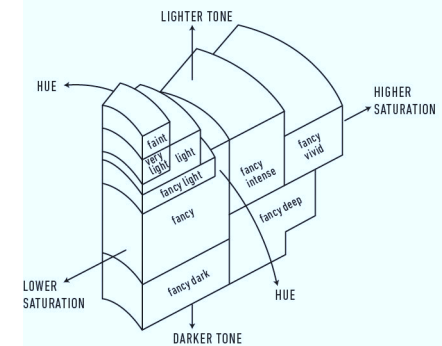

Illustration of GIA fancy color grade interrelationships

GIA CLARITY SCALE

| | |
|-----------------------------|---------------------|
| VERY VERY SLIGHTLY INCLUDED | FLAWLESS |
| | INTERNALLY FLAWLESS |
| VERY SLIGHTLY INCLUDED | VVS ₁ |
| | VVS ₂ |
| SLIGHTLY INCLUDED | VS ₁ |
| | VS ₂ |
| INCLUDED | SI ₁ |
| | SI ₂ |
| | I ₁ |
| INCLUDED | I ₂ |
| | I ₃ |



The results documented in this report refer only to the diamond described, and were obtained using the techniques and equipment used by GIA at the time of examination. This report is not a guarantee or valuation. For additional information and important limitations and disclaimers, please see www.gia.edu/terms or call +1 800 421 7250 or +1 760 603 4500. ©2014 Gemological Institute of America, Inc.

reportcheck.gia.edu



 THE SECURITY FEATURES IN THIS DOCUMENT, INCLUDING THE HOLOGRAM, SECURITY SCREEN AND MICROPRINT LINES, IN ADDITION TO THOSE NOT LISTED, EXCEED DOCUMENT SECURITY INDUSTRY GUIDELINES.